

Electrostatic Discharged Protection Devices (ESD) Data Sheet

Description

Brightking's LBT23C12L02 component is designed to protect sensitive electronics from damage or latch-up due to ESD and other voltage induced transient events. It is designed for use in applications where board space is at a premium. The device will protect up to two lines. It is bidirectional devices and may be used on lines where the signal polarities are above ground. TVS diodes are solid state device designed specifically for transient suppression. It feature large cross-sectional area junctions for conduction high transient currents. It offer desirable characteristics for board level protection including fast response time, low and clamping voltage, and no device degradation. The device may be used to meet the immunity requirements of IEC61000-4-2, level 4.



Contact : $\pm 30\text{kV}$
Air : $\pm 30\text{kV}$



Features

- IEC61000-4-2 ESD $\pm 30\text{kV}$ Air, $\pm 30\text{kV}$ contact compliance
- SOT-23 surface mount package
- Protects bidirectional two I/O lines
- Peak power dissipation of 100W under 8/20 μs waveform
- Working voltage: 12V
- Low leakage current
- Low operating and clamping voltages
- Solid-state silicon avalanche technology
- Lead Free/RoHS compliant
- Solder reflow temperature: Pure Tin-Sn, 260~270 $^{\circ}\text{C}$
- Flammability rating UL 94V-0
- Meets MSL level 1, per J-STD-020
- Marking: B L12

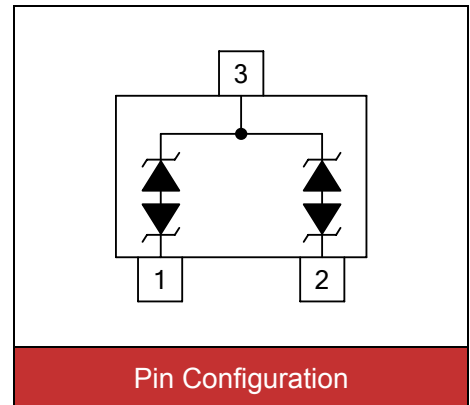

Applications

- Keypads, data lines, buttons
- Notebook computers
- Portable handheld devices
- Digital Cameras
- Portable GPS
- MP3 players

Maximum Ratings

Rating	Symbol	Value	Unit
Peak pulse power (tp=8/20 μs waveform)	P_{PP}	100	W
Peak pulse current (tp=8/20 μs waveform)	I_{PP}	2.5	A
ESD voltage (Contact discharge)	V_{ESD}	± 30	kV
ESD voltage (Air discharge)		± 30	
Storage & operating temperature range	T_{STG}, T_J	-55~+150	$^{\circ}\text{C}$

Electrical Characteristics ($T_J=25^{\circ}\text{C}$)

Parameter	Symbol	Condition	Min.	Typ.	Max.	Unit
Reverse stand-off voltage	V_{RWM}				12	V
Reverse breakdown voltage	V_{BR}	$I_{BR}=1\text{mA}$	13.3			V
Reverse leakage current	I_R	$V_R=12\text{V}$ Each I/O pin			1	μA
Clamping voltage ($t_p=8/20\mu\text{s}$)	V_C	$I_{PP}=1\text{A}$			25	V
Clamping voltage ($t_p=8/20\mu\text{s}$)	V_C	$I_{PP}=2.5\text{A}$			30	V
Off state junction capacitance	C_J	0Vdc, $f=1\text{MHz}$ Between I/O pins and GND		8	15	pF

Typical Characteristics Curves

Figure 1. Power Derating Curve

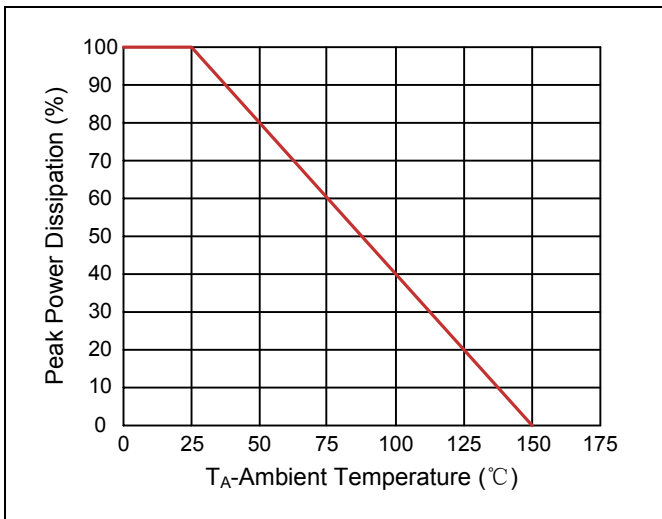

Figure 2. Pulse Waveforms

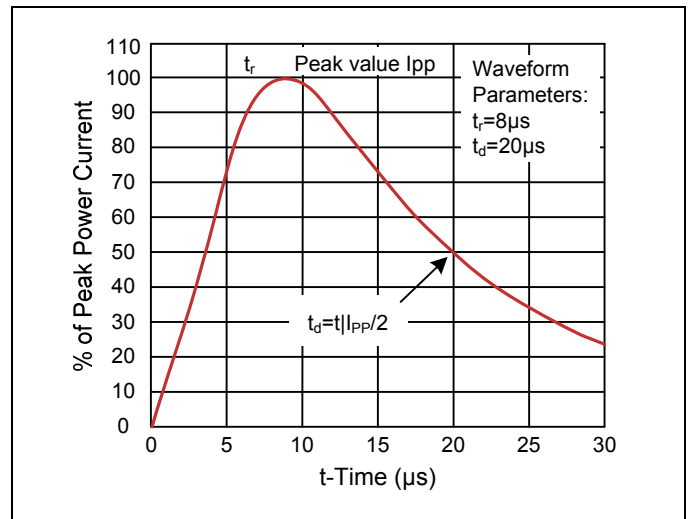

Figure 3. Clamping Voltage vs. Peak Pulse Current

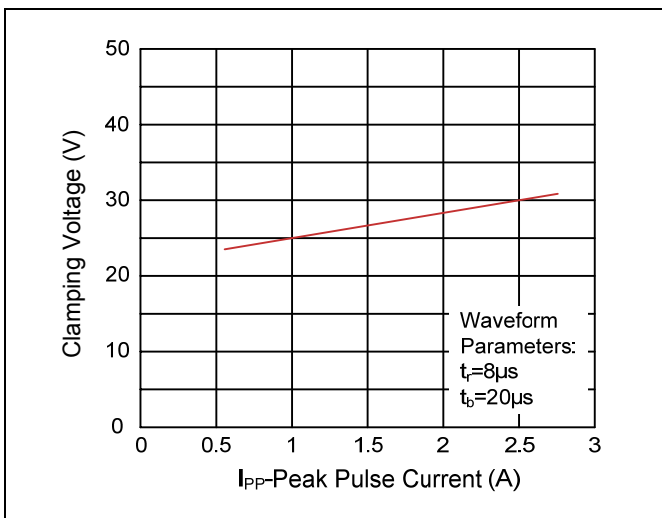
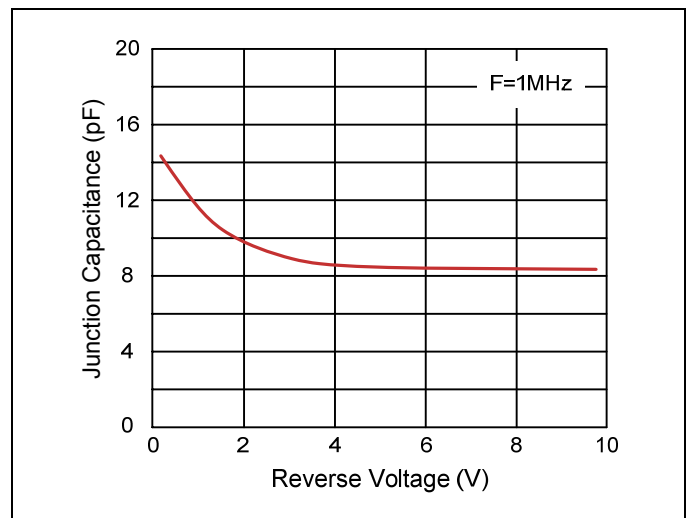
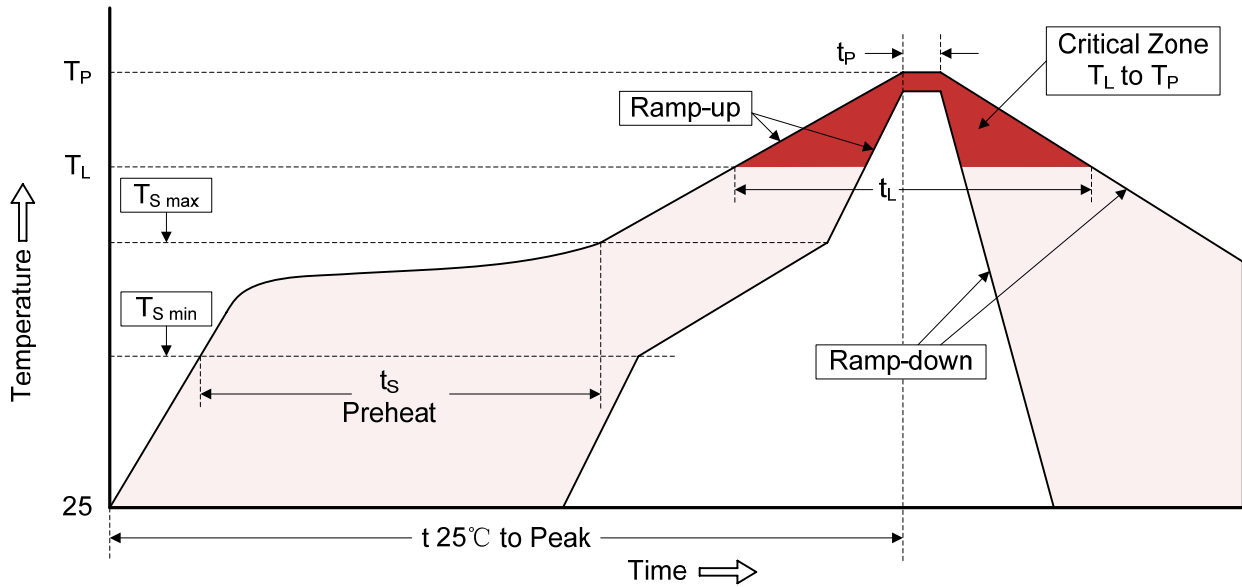

Figure 4. Normalized Capacitance vs. Reverse Voltage



Recommended Soldering Conditions

Reflow Soldering



Recommended Conditions

Profile Feature	Pb-Free Assembly
Average ramp-up rate (T_L to T_P)	3°C/second max.
Preheat -Temperature Min ($T_{S\ min}$) -Temperature Max ($T_{S\ max}$) -Time (min to max) (t_s)	150°C 200°C 60-180 seconds
$T_{S\ max}$ to T_L -Ramp-up Rate	3°C/second max.
Time maintained above: -Temperature (T_L) -Time (t_L)	217°C 60-150 seconds
Peak Temperature (T_P)	260°C
Time within 5°C of actual Peak Temperature (t_P)	20-40 seconds
Ramp-down Rate	6°C/second max.
Time 25°C to Peak Temperature	8 minutes max.

Dimensions (SOT-23)

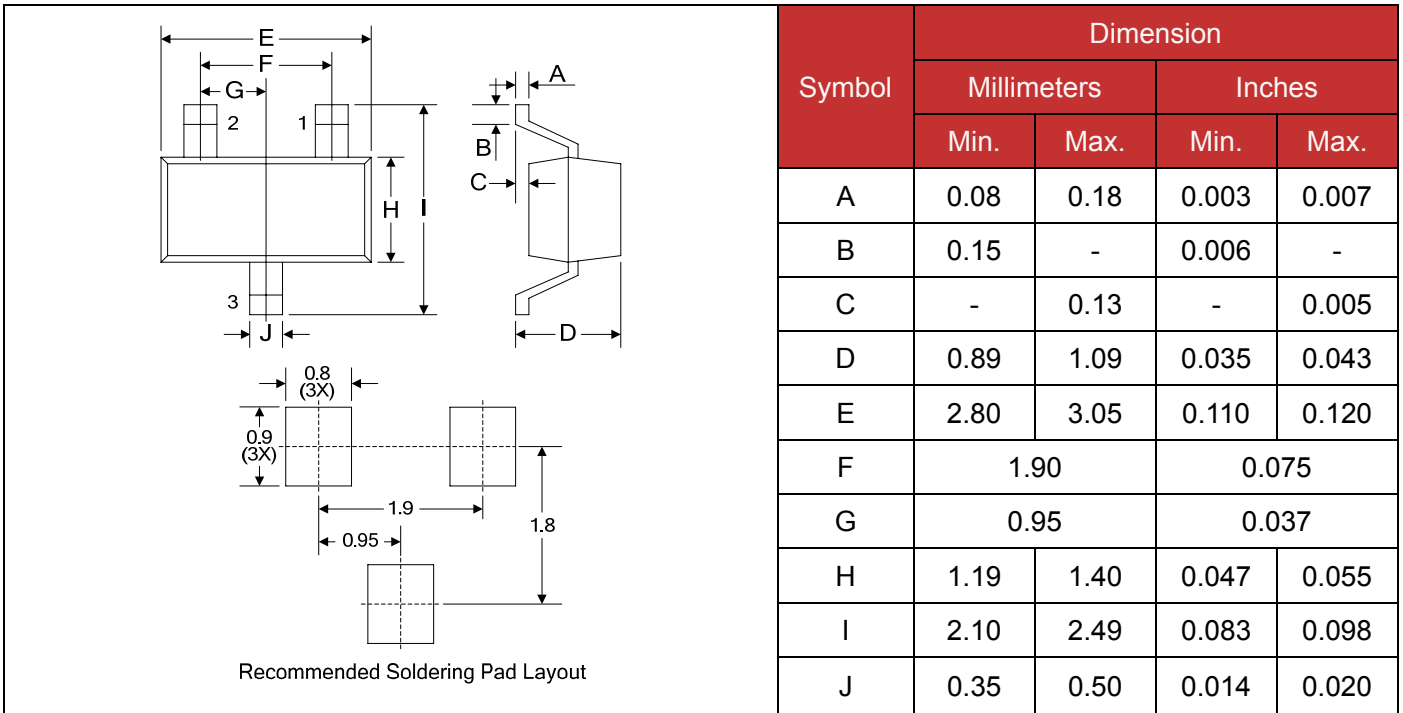

Packaging

